

The Benefits of a Vertically Integrated Optical Systems Supplier

Daniel Staloff
Corning Advanced Optics, 60 O'Connor Rd, Fairport, NY 14450
StaloffDM@Corning.com

ABSTRACT

A company that specifies optical systems with multiple assemblies has several procurement choices: Contract different sub-assemblies to multiple companies or find a single company that has the range of capabilities to complete all the optical systems. There are advantages to working with a company that has a large suite of capabilities and is vertically integrated.

A vertically integrated optical system manufacturer can deliver on all parts of the optical system supply chain: optical material, optical and mechanical finishing, thin film coating, assembly, testing, and packaging. The benefit to working with a company that has capabilities in each of these areas is the knowledge and expertise of the individual process details and the understanding of the downstream impact of each process. This knowledge can lead to improved Design For Manufacturability (DFM) which can reduce the complexity, reduce cost of the end product, and ensure product performance.

Obtaining maximum optical performance of multiple optical assemblies sourced from different suppliers can be a difficult task. Often the result is more challenging specifications on the individual assemblies to guarantee the performance of the entire system. This can lead to increased cost, complexity, and lead time. By using multiple suppliers, there are additional risks such as mechanical interface mismatch, optical performance failure, and stray light.

Keywords: Design for Manufacturability, DFM, vertical integration, concurrent engineering

1. INTRODUCTION

The marketplace for optical components has many suppliers around the world all of whom have similar capabilities. In fact, the Photonics Buyers Guide¹ lists 1311 suppliers of optical components. All 1311 suppliers don't have the same products or capabilities, but the large number speaks to the breadth of potential optical suppliers in the optics marketplace. In person, one can see this expansive marketplace at the SPIE Photonics West trade show. In 2018, there were over 1300 registered exhibitors². How does a company distinguish itself from all of its competitors? One method is to add capabilities and strive toward vertical integration. A company that is vertically integrated can provide more value to its customers by improving lead times, reducing costs, and simplifying the supply chain.

According to the traditional economic definition, vertical integration is the combination, under a single ownership, of two or more stages of production or distribution (or both) that are usually separate². At a high level, optical systems are typically comprised of several optical elements which are held together with one or more mechanical elements. The details of the each optical system will be determined not only by the required specification but by the manufacturing capabilities of the supplier.

2. Vertical Integration Benefits

There are many suppliers in the optics field. Some only polish flats. Some polish curved surfaces, but don't coat optics. Some coat optic but don't polish. Some can do all of the above but don't do any assembly. Given the varying degree of capabilities, it can be challenging for a company procuring an optical lens assembly to know where to start. The easiest thing to do from a procurement standpoint, is to find a supplier who delivers on all the needed steps, one who is vertically integrated. For this paper, an optical system supplier is considered vertically integrated with both people (many engineering disciplines) and machine power (optical and mechanical finishing, thin film coating) if they have the following capabilities:

<u>Design and Engineering Capabilities</u>	<u>Manufacturing Capabilities</u>
Optical	Optics fabrication
Mechanical	Mechanical fabrication
Thin Film	Thin Film Deposition
Manufacturing	Optical Assembly
Metrology	System Test

Table 1: Capabilities List

Having all these capabilities within one building, or even one organization has benefits to both the customer and supplier. The customer can find a single business to work with and give them a specification document or describe the needs of the system in even broader terms. The vertically integrated supplier has the ability to design an optical system which meets these needs. Within the supplier, optical designers can get quick feedback from their fellow engineers in other disciplines. This allows for quicker design turn around. For example, in a vertically integrated supplier, an optical designer can walk within the same building to other engineers and confirm items such as:

- acceptable lens diameters for polishing machines and coating chambers
- optical element edge thicknesses
- optical surface runouts based on a particular mounting strategy
- number of elements which can fit in the coating chamber
- expected thin film performance
- manufacturing tolerances

These are just a few important items for consideration. To gather this amount of information from an array subcontractors could take many days or weeks after setting up conference calls or waiting for responses to email.

The benefit of having all of the engineering and manufacturing resources in one organization is the ability to efficiently design and build a system based on known capabilities. This process is known as DF/X, Design For X, where X can be manufacturability, assembly, safety, cost, serviceability, etc... Effective use of this process leads to faster product development, increased quality, lower cost, and shorter lead times.

3. Design for Manufacturing and Concurrent Engineering

Being both vertically integrated in manufacturing processes and engineering personnel allows for concurrent engineering. Concurrent engineering is the practice of concurrently developing products and their manufacturing processes. Additionally, this allows for product development teams that include both engineering and manufacturing personnel. This eliminates cases where engineers made assumptions about capabilities and processes. With this continuous communication between manufacturing and engineering, the design phase of a product life cycle can be more effective.

There are several design for manufacturability guidelines that can be used in effective opto-mechanical system design⁴:

1. Understand manufacturing problems/issues of current and past products
2. Design for easy fabrication, processing, and assembly
3. Adhere to specific process design guidelines
4. Design for fixturing
5. Minimize tooling complexity by concurrently designing tooling
6. Specify optimal tolerances for a robust design
7. Specify parts from reliable sources
8. Minimize Setups
9. Minimize Cutting tools
10. Understand tolerance step functions and specify tolerances wisely

All of these actions can result in quicker manufacturing time, better quality, and lower cost. The result is a more competitive product in the marketplace. The ability to accomplish these efficiencies also leads to new product innovation and introduction by better understanding processes and capabilities. As reported in the Harvard Business Review, Buzzell showed that a high level of integration corresponds to high rates of new product introduction³.

In optical systems, once a system passes beyond prototype production, it is challenging to make significant cost reductions without sacrificing performance and quality. Eighty percent of the lifetime cost of a product will be determined by the product design⁴. Optical elements can't be polished quicker without sacrificing quality such as surface irregularity or roughness. One method to reduce cost is with batch processing, typically in polishing, thin film coating, or molding. Batching opportunities may be possible, but can only be done with certain optical element geometries, making this cost saving opportunity not widely available to all systems. Fitting many parts into a coating chamber is a possible method to do batch processing. The downside to large batches in coating may be coating performance uniformity across parts or the chance for an upset during the coating process, requiring rework or scrapping of all the optics. Moving to molded solutions in glass or plastic might be viable for visible and infrared wavelength systems, but there potential sacrifices in performance in surface quality, polarization properties, and thermal property changes to be aware of. The result is that the largest cost savings are designed into the system from the beginning, not implemented in a cost saving strategy afterwards.

Trying to save cost by outsourcing more parts or activities to reduce overhead costs will still result in the same effective overhead cost. All of the down stream suppliers and sub-contractors will likely have a similar overhead structure. A pictorial example of this is given in Figure 2. With the inability to save costs in this manner, vertical integration and concurrent engineering can help reduce costs upfront in the design.

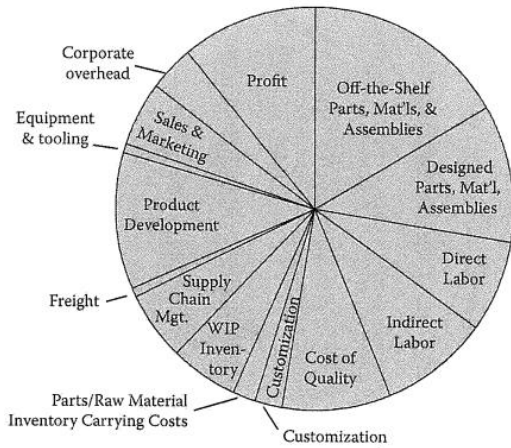

Figure 1: Example Product Cost Structure⁴

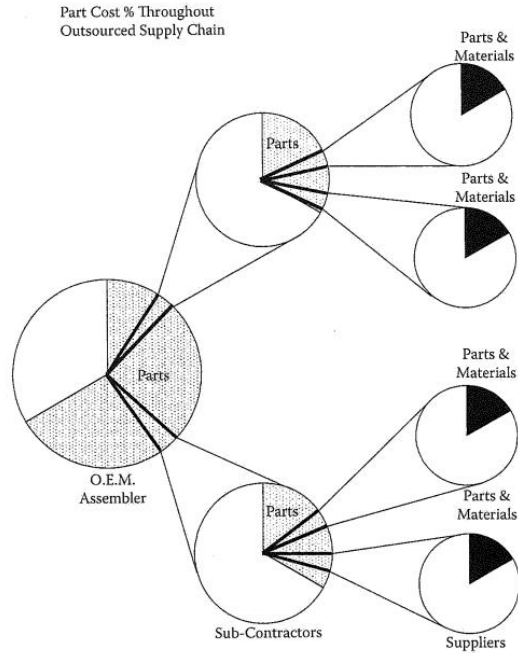

Figure 2: Product Cost Structure with Suppliers⁴

4. Example of Design for Manufacturing in Practice

The need for a vertically integrated supplier increases with system complexity and demanding system specifications. In this example, best practices of concurrent engineering were used to develop a manufacturing strategy to build the tube lens illustrated in Figure 3. This tube lens operates simultaneously with a high NA objective. The combined system, tube lens and objective, is only allowed small variations in distortion of 0.65 microns. Prior to manufacturing the lens system, a monte carlo analysis was performed. The results indicated that the objective would yield a 0.02% change in magnification, which would result in too much distortion for this application. Additionally, the system environmental conditions would also contribute unacceptable magnification variations.

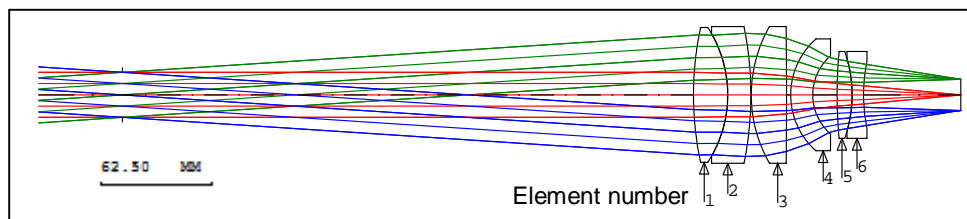

Figure 3: Tube lens

There were multiple engineers who worked to finalize the optical design. The optical design engineer worked with an optical fabrication process engineer to finalize lens aspect ratios, review material properties (hardness, water resistance, etc), and achievable tolerances. Concurrently, the optical design engineer also worked with a thin film engineer to review the system spectrum, angles of incidence, material properties, and transmission requirements. In addition, there was also a review between optical design and a manufacturing engineering about doublet assembly.

As shown here, the benefit to a vertically integrated engineering department is that it allows for concurrent engineering even at the beginning of the design process. An external design consultant might be capable of a similar design, but the value added of quick and fruitful interaction and design feedback pays many

dividends: Improved chances of success, no assumptions based on rules of thumb, and team buy in that the design is able to be manufactured. At least four engineers have already reviewed the design before the discussion of magnification compensation.

The requirement for magnification correction resulted in the need for a moveable element(s) in either the objective or tube lens. Because the objective is primarily optimized for wavefront performance, it was determined by the optical design engineer that the magnification correction should happen with the tube lens.

Figure 5 shows the system magnification sensitivity to element shifts along the optical axis. Using the sensitivity information and previous design experience with moveable elements, the engineering team decided that the elements 5-6 doublet would be the ideal candidate to do the magnification correction. While elements 3 and 4 would have required less motion for magnification compensation, the 5&6 doublet location at the outside of the lens stack allowed for easier implementation of motion control. As a result of moving an element, the tube lens working distance, the distance from the last element to the image plane, changed as well. Other system requirements forced the camera to be in a static position. This forces the requirement to move the entire tube lens to maintain focus at the camera sensor as doublet 5&6 was in continuous motion, similar to how a zoom lens works. The motions needed to be done actively to account for changing environmental conditions.

The result of the need to move doublet 5&6 and the entire tube lens assembly required all engineering disciplines to be involved. An optical engineer provided the motion range and resolution requirements. Electrical and mechanical engineering worked together to find motion controls and mechanics to meet the motion specifications. Manufacturing engineers helped guide the design with insights as to how the product would be assembled.

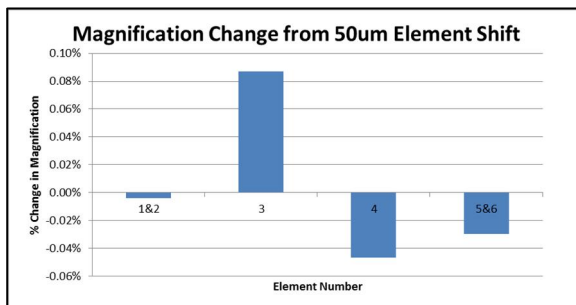

Figure 4: Magnification Sensitivity

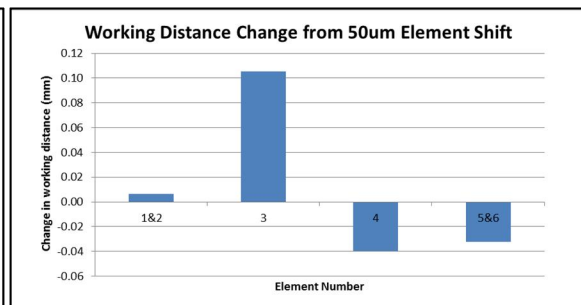

Figure 5: Working Distance Sensitivity

One approach to enable best assembly practices was to 3D print the assembly in piece parts. This enabled engineers to practice building their own designs without the need for custom machined parts. 3D printing and assembly of a prototype design also allowed for rapid design iteration in days, instead of the several weeks it would have taken to produce or procure custom machined parts. As seen in the figure below, there are noticeable mechanical changes between an early 3D printed model and the rendering of the final iteration.

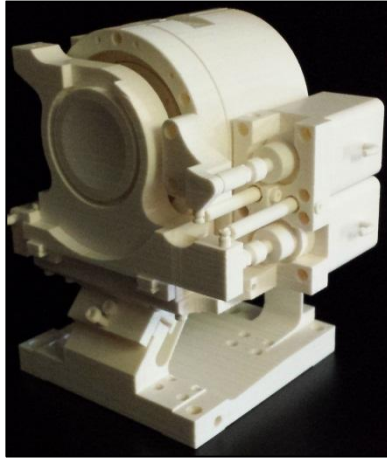

Figure 6: 3D printed Model

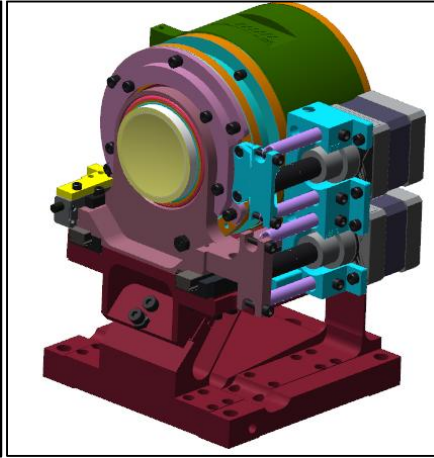

Figure 7: Rendering of final assembly

Mechanical and manufacturing engineers also worked together to change the groupings of the lenses in mechanical cells. In the original configuration, it would have been challenging to dispense and cure the adhesive for doublet 1&2 because the adhesive bondline, which connects the optic to the mechanic, was deep within the mechanical cell barrel. Switching to the final configuration solved the dispensing and curing problem. This was likely to ensure a more uniform adhesive application and fuller cure, which increased quality of the product.

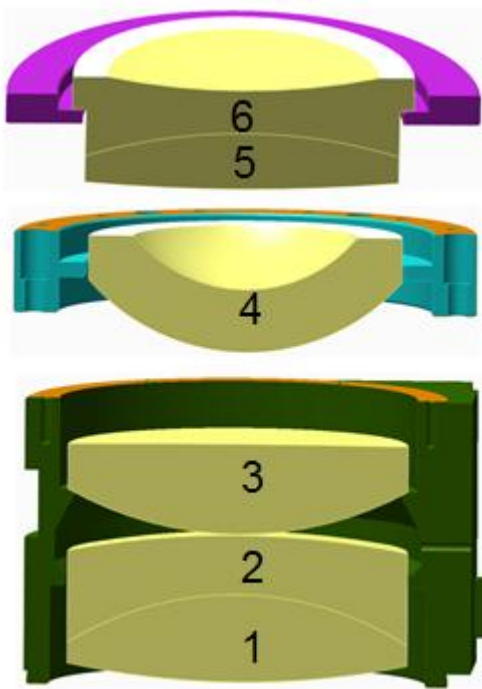

Figure 8: Original Configuration

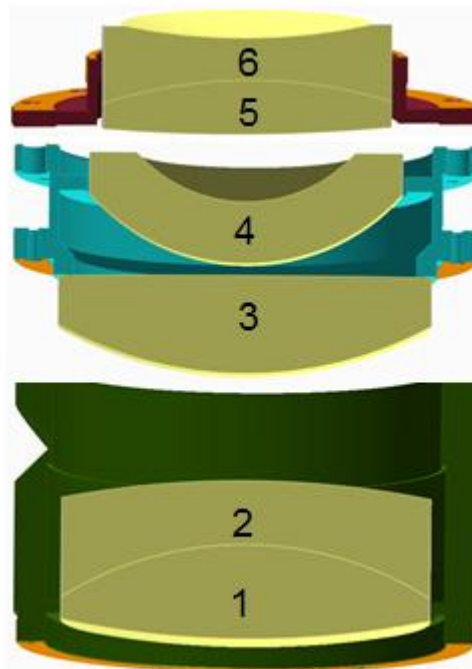

Figure 9: Final Configuration

5. Conclusion

If the customer decided to source the objective and tube lens separately, it would have driven the manufacturer of each lens toward tighter and more stringent specifications to ensure compatibility and performance, increasing costs and lead times. The tube lens example shown here uses nearly all of the

effective manufacturability guidelines outlined in Section 3. The ability to accomplish this can only be done with the atmosphere created by vertical integration and the discipline to use DFM methodology. Vertical integration can provide benefits such as shorter lead times, lower cost, increased quality, and more innovation.

6. References

[1] Photonics Media, 2018 Photonics Buyers Guide, 2018.

[2] New Wave of Optics and Photonics On Display As 23,000 Registered Researchers, Engineers, Buyers, and Suppliers Converge at SPIE Photonics West 2018. (2017, February 7). Retrieved March 28, 2018, from <https://spie.org/about-spie/press-room/press-releases/new-wave-of-optics-and-photonics-on-display-as-23000-registered-researchers-engineers-buyers-and-suppliers-converge-at-spie-photonics-west-2018>

[3] Buzzell, R.D., "Is Vertical Integration Profitable?". Harvard Business Review. January 1983.

[4] Anderson, D. M., Design for Manufacturability, Taylor and Francis Group, New York (2014).