

GENERAL INFORMATION

1. Additional relevant documentation:

- MRU quick installation sheet provided with the unit (or download from Corning partner portal: CMA-398-AEN)
- Purcell FlexSure® 12-GR487 installation manual provided with the cabinet

2. Only trained and qualified personnel should be allowed to install, replace, or service this equipment.

3. Corning recommends using the Mean Well SDR-140-48 DIN rail AC/DC converter or equivalent.

4. The MRU connections are performed after the chassis is installed in cabinet.

This document provides instructions on how to install the Corning® optical networks evolution (ONE™) solutions mid-power remote (MRU) into a Purcell cabinet (FlexSure 12RU outdoor GR-487 enclosure) and perform external alarm connections between the unit and the enclosure.

1. KITS REQUIRED FOR INSTALLATION

The following kits are required for installing the MRU in the outdoor enclosure. Each kit is ordered separately.

Kit	Item	Quantity
FLX12-GR487 Enclosure	Purcell FlexSure 12U Outdoor GR-487 Enclosure for single MRU installations SISO cabinets: <ul style="list-style-type: none"> • Purcell 2000004343 FLX12-GR487-R, 39W/C HEX, right-hinge door • Purcell 2000004344 FLX12-GR487-L, 39W/C HEX, left-hinge door 	1
MRU-E-XXXXX-AC/DC	Mid-Power Remote Unit	1
AK-MRU-DCA-CBL	External Alarms Cable; DB9 male open wire cable for external alarm connections	1
AK-FLX1216-POLE-MK (optional)	Platform Pole-Mountable Kit for FLX12 and FLX16 outdoor enclosures Purcell P/N: 2000003986	1
AK-FLX12-WALL-MK (optional)	Wall-Mountable Kit for FLX12 outdoor enclosures and assemblies P/N 2000003985	1

Table 1. Required Kits

2. ADDITIONAL REQUIRED ITEMS (NOT SUPPLIED)

- Standard electrician tools (including ratchet wrench with extension bar and 8-mm socket) for tightening self-drilling screws securing MRU chassis to cabinet rails
- Assorted cable ties
- 90-degree right-angle 4.3-10 type male connector coax cables – one for antenna connection and one for external 2.5 GHz RF source connection (if relevant)
- Recommended – Flexible cable conduits for routing connection cables through cabinet knockouts; refer to Figure 2 for relevant knockouts. Following are recommended Heyco part numbers for flexible conduits (or equivalent):

Manufacturer Part Number	Description
8406	HFC 1 Conduit Fitting with 8467 nut, 1-in thread, black
8453	HF2 1 Tubing, 100-ft coil, black
8456	HFC 2 Tubing, 50-ft coil, black
8642	HFC 2 Conduit Fitting, 2-in thread, black

Table 2. Recommended Conduits

- Sealing material for knockouts – if not using conduits
- Recommended DIN rail power supply for MRU AC models – Mean Well SDR-120-48 or equivalent; Input: 100-240 V AC; 1.4 A 50/60 Hz; Output: 48 V; 2.5 A
- DIN rail TS-35/7.5 or 15 – cut to the length between the enclosure internal upright brackets; used for mounting DIN rail power supply
- Slotted 4-mm screwdriver – for SDR wiring

3. PRE-INSTALLATION PROCEDURES

- Step 1:** Remove each rack ear and reassemble according to position shown in Figure 1.
- Step 2:** Referring to Figure 2 for relevant knockouts, use appropriate knockout tools to punch out knockouts for routing connection cables.

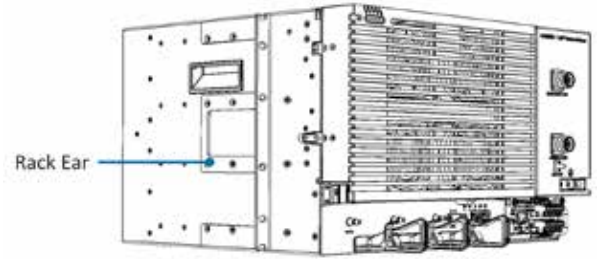

Figure 1. Required Position of MRU Rack Ears

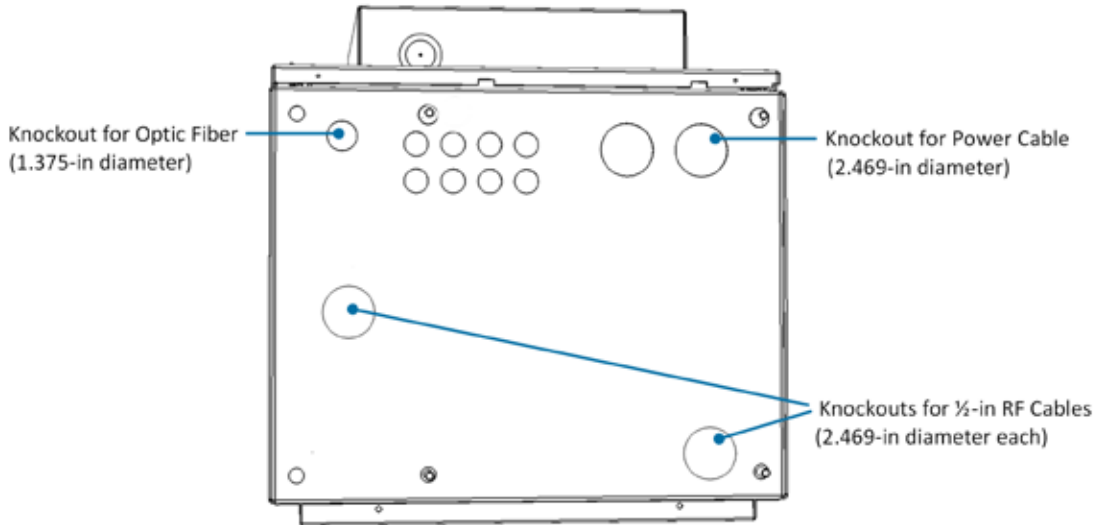

Figure 2. Required Knockout Positions

⚠ ATTENTION! In the event that a PAM or the OPTM needs to be removed from the chassis, make sure to first press the release button on the module and then pull out using the handle (see Figure 3). Any attempt to pull out the module without first releasing may cause damage.

Corning will not be liable for damage of products resulting from improper handling during installation or repair.



Figure 3. Extraction of PAM/OPTM

4. INSTALL MRU IN CABINET

Step 1: Carefully lay cabinet on backside (so door faces upward) and open door.

⚠ ATTENTION! Make sure that the door hatch locks into the door rail in order to avoid closing of door while installing the chassis. See Figure 4.

Note: Push hatch inward towards the door to release and close the cabinet.

Step 2: Insert one 8-mm self-tapping screw (provided with the cabinet) halfway into the bottom hole of each rail. Refer to Figure 5.

Note: An extension bar may be required to access the screws due to narrow space between chassis and cabinet rails.

Step 3: Position the bottom-half slots of the MRU rack ears onto the protruding screws and tighten the screws using a ratchet wrench. Refer to Figure 6.

Step 4: Insert at least two additional screws into each of the cabinet rails to safely secure MRU and tighten.

5. (OPTIONAL) INSERT CONDUITS IN KNOCKOUTS

Insert the appropriate conduits in each of the punched-out knockouts.

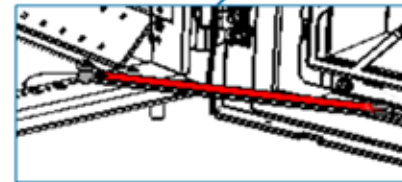
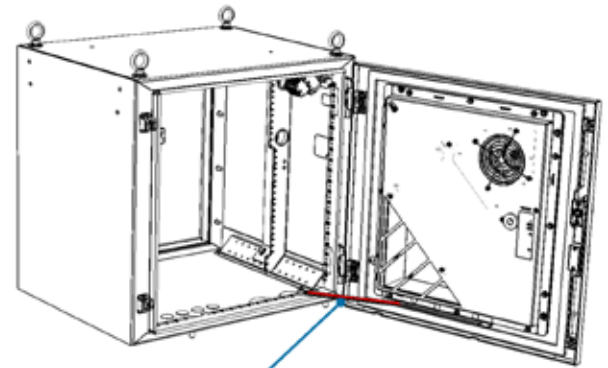

Open Door All the Way to Lock Hatch in Place

Figure 4. Opening Cabinet Door and Locking in Place

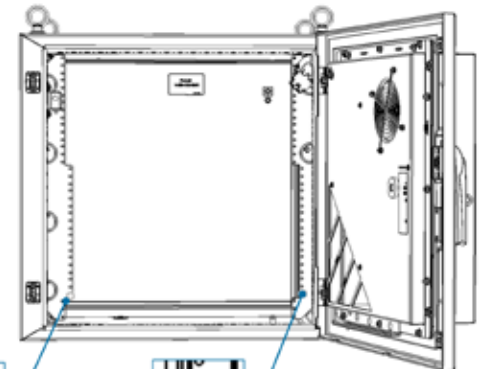

Figure 5. Inserting Self-Tapping Screw in Each Rail

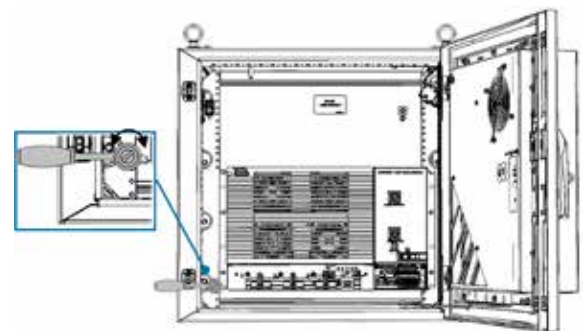

Figure 6. Securing MRU to Cabinet Rails

6. GROUND CABINET AND MRU

- Step 1:** Ground cabinet – refer to the manufacturer’s installation guide for instructions on cabinet grounding.
- Step 2:** Using one of the grounding cables provided with the cabinet, ground the MRU chassis via the two-hole, standard-barrel grounding lug located on the front panel to one of the cabinet grounding bolts. Refer to Figure 7.

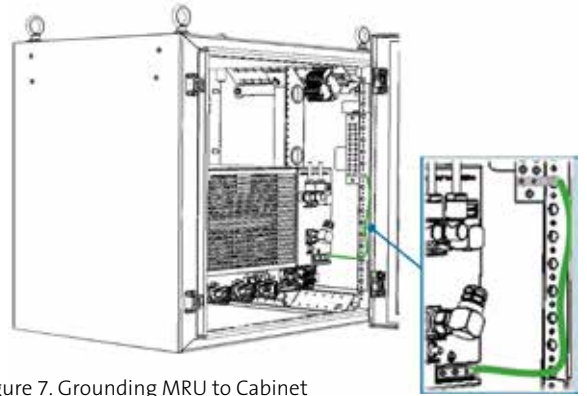

Figure 7. Grounding MRU to Cabinet

7. CONNECT RF ANTENNA COAX

For both 4.3-10 Type “ANTENNA PORT” and “2.5 GHz INPUT PORT” – route coax cable (with 90-degree right-angle connector) through its designated knockout (see Figure 2) behind and above the MRU chassis and connect to the corresponding RF port. Refer to Figure 8.

8. ROUTE FIBER AND POWER CABLES

IMPORTANT! If cables are routed without the use of conduits, the knockouts must be sealed using appropriate sealing materials.

Route optical fiber from path panel and power cable through designated knockouts (see Figure 2) and connect according to instructions in MRU quick installation sheet. Refer to Figure 8.

Note: For DC power connections, route DC power cable with open wires (without connector) and then wire according to instructions in MRU quick installation sheet (CMA-398-AEN).

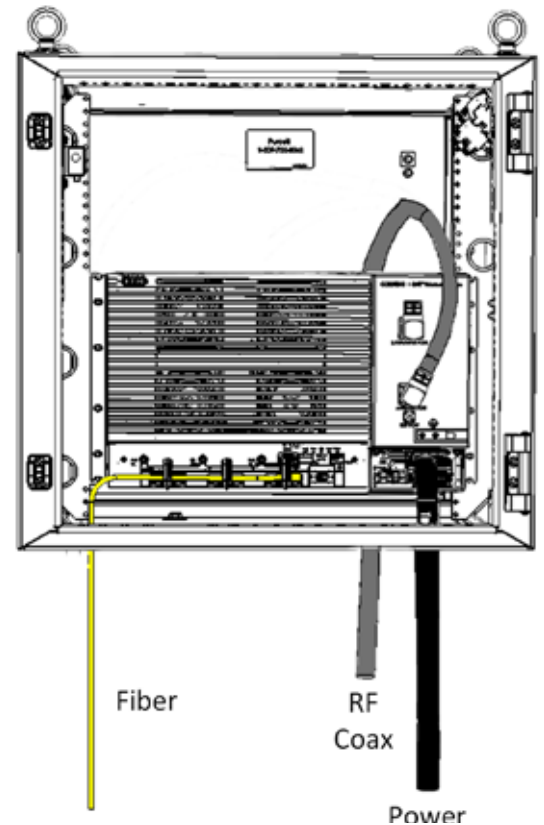

Figure 8. Example of Routed Connection Cables

9. INSTALL AND CONNECT DIN RAIL POWER SUPPLY (RECOMMENDED FOR MRU AC MODELS)

Recommended DIN rail power supply:

- Type: Mean Well SDR-120-48 or equivalent
- Input: 100-240 V AC; 1.4 A 50/60 Hz
- Output: 48 V; 2.5 A
- Recommended fuse and maximum number of SDR-120 PSUs for a 230 V circuit breaker:

Fuse	Circuit Breaker	
	C16	D16
T4A / L250V	7	14

Step 1: Secure the DIN rail to the upright brackets in the enclosure.

IMPORTANT! Make sure to install the DIN rail so that there is equal space above and below the power supply to be mounted. This is required to ensure sufficient airflow.

Step 2: Mount the DIN rail power supply onto the **right side** of the installed rail, as shown in Figure 9.

Wiring requirements:

- Use copper wires only.
- Use wires that can withstand a minimum temperature of 80°C (e.g., UL1007).
- Recommended wire strapping length = 0.197 in (5 mm).
- Recommended wires:

AWG	18	16	14	12	10
Rated Current of Equipment (Amp)	6	6-10	13-16	16-25	25-32
Cross-Section of Lead (mm ²)	0.75	1.00	1.5	2.5	4

- Notes:**
- When using five or more wires connected to the unit, the current of each wire should be derated to 80 percent of the recommended current above.
 - The maximum allowable cross-sectional area of the wire for the SDR terminal is 12 AWG/2.5 mm²

Step 3: Using 3 A gauge wires, connect pair of DC wires from the “-V” and “+V” terminal block connectors to the socket box on the right of the enclosure.

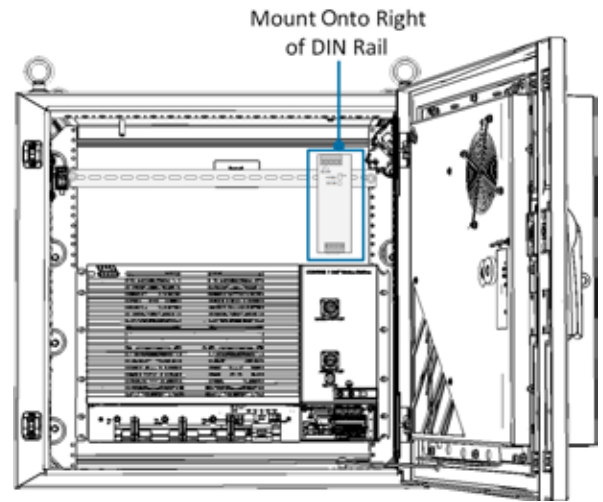

Figure 9. Installation Location of DIN Rail Power Supply

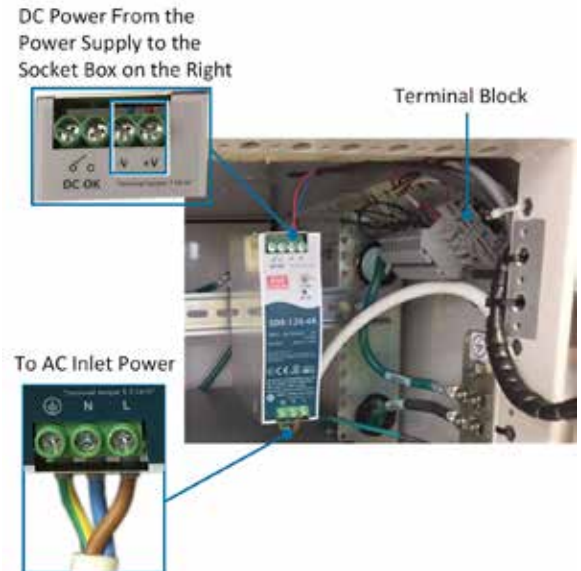

Figure 10. Overview of Recommended SDR Connections

Step 4: Using 2 A gauge double-insulation wire, connect SDR to AC inlet power.
See Figure 11 for illustration of connections between external enclosure and DIN rail power supply.

IMPORTANT! Make sure that all strands of each stranded wire enter the terminal connection and the screw terminals are securely fixed to ensure good contact. If the power supply consists of multiple output terminals, make sure each contact is connected to wires to prevent excess current stress on a single contact.

10. PERFORM EXTERNAL ALARMS CONNECTIONS BETWEEN MRU AND CABINET

Note: Also refer to relevant section of the cabinet installation manual (i.e., “Connecting Optional Custom Alarms”).

Step 1: Connect the external alarms cable (ordered separately) to the chassis’ DB9 “External Alarms” connector.

The connector provides indications for door opening, heat exchanger (HEX), and one additional input for future use.

Refer to Table 3 and Figure 11 for MRU “External Alarms” connector pinout and location.

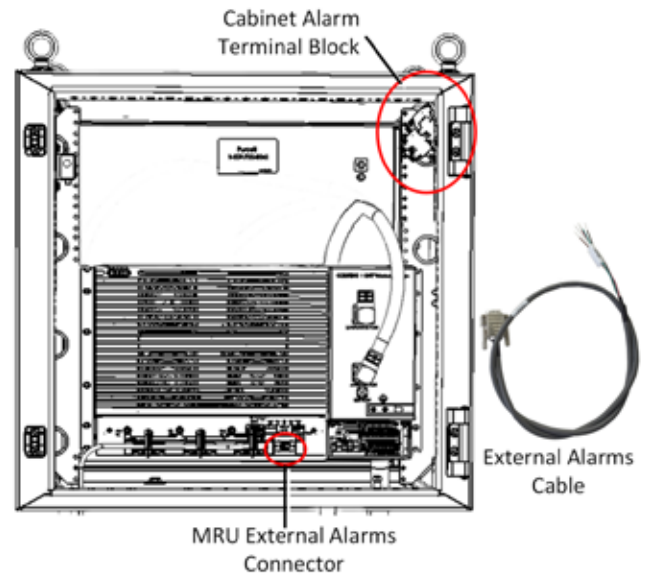

Figure 11. Location of External Alarms Connector and Cabinet Alarms Block

Pin	Description
1	Common
2	Not connected
3	Not connected
4	Not connected
5	Not connected
6	Door alarm
7	HEX alarm
8	Future alarm
9	Exist indication (indicates existing connection of alarm cable)

Table 3. MRU “External Alarms” Connector Pinout Description

Step 2: Route the cable alarm wires to the alarm block, located on the cabinet's upper right corner

Step 3: Connect the external alarm connections to the cabinet according to Table 4.

Color	Description
Red	+48 V _COMMON
Green	-48 V _EXIST INDICATION
Brown	-48 V _DOOR ALARM
Black	-48 V _HEX ALARM
White	-48 V _FUTURE ALARM

Table 4. External Alarms Cable Wiring Description

Refer to Table 5 for wiring description of MRU external alarms connector and to Figure 12 for examples of the upper and lower cabinet block wiring connections.

External Alarms Connector Pin No.
1 Common
6 Door Alarm
2 NC
7 HEX Alarm
3 NC
8 Future Alarm
4 NC
9 Exist Indication
5 NC
<i>Note: NC = Not Connected</i>

Table 5. External Alarms to Cabinet Block Wiring

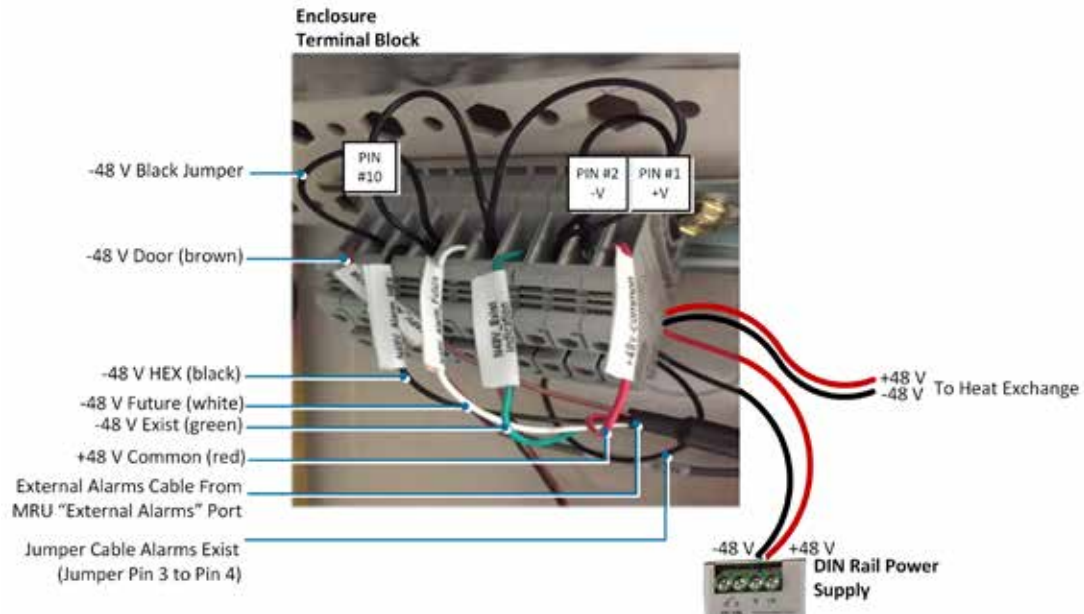

Figure 12. Example of External Alarm Wiring Connections (with DIN Rail Power Supply)

11. VERIFY NORMAL OPERATION

- Step 1:** Verify that fans are operational.
- Step 2:** Refer to status LEDs on the inside of the cabinet door and verify that all show green.

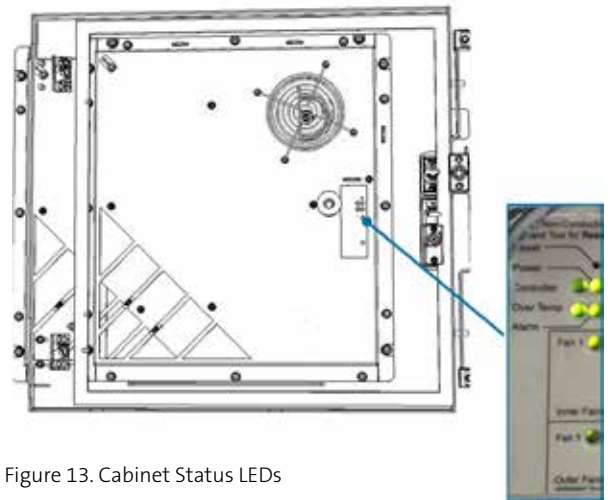

Figure 13. Cabinet Status LEDs

NOTES

NOTES

NOTES

Corning Optical Communications LLC • PO Box 489 • Hickory, NC 28603-0489 USA
800-743-2675 • FAX: 828-325-5060 • International: +1-828-901-5000 • www.corning.com/opcomm

Corning Optical Communications reserves the right to improve, enhance, and modify the features and specifications of Corning Optical Communications products without prior notification. A complete listing of the trademarks of Corning Optical Communications is available at www.corning.com/opcomm/trademarks. All other trademarks are the properties of their respective owners. Corning Optical Communications is ISO 9001 certified. © 2015, 2017 Corning Optical Communications. All rights reserved. CMA-437-AEN / August 2017

P/N 709C01802 Rev A00